

HEAT SINK WITH CLIPPING SYSTEM

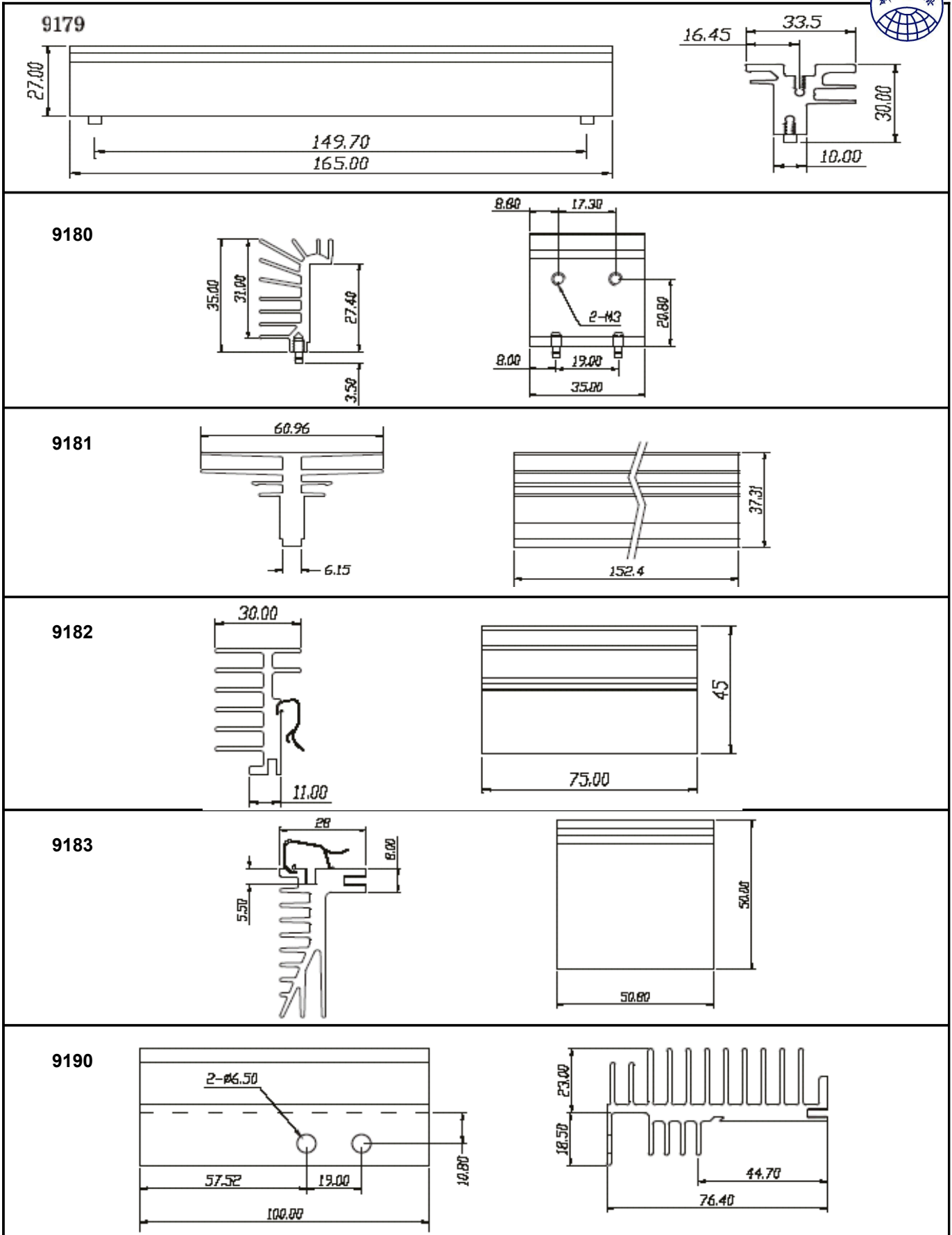

HEAT SINK WITH CLIPPING SYSTEM



9189

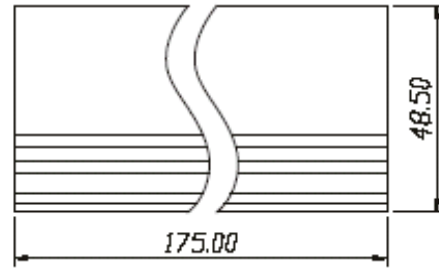
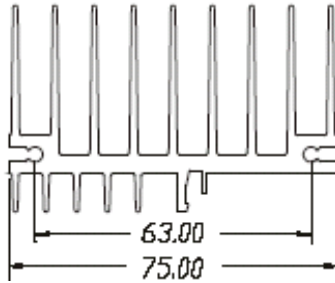

9185

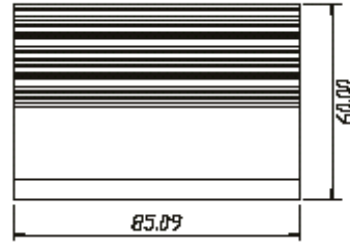

9186

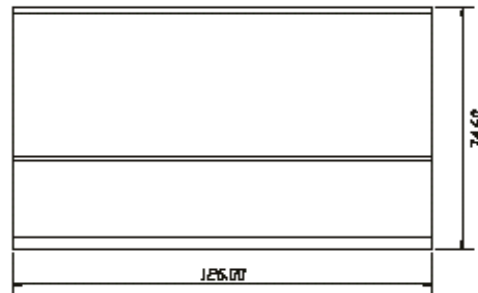
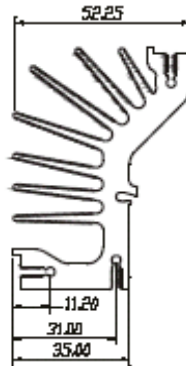

9191

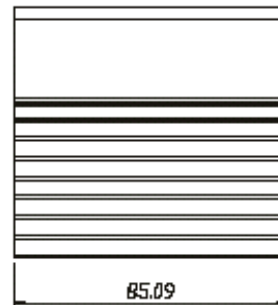
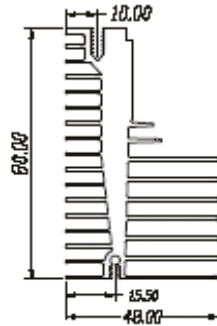

- * Specification: Length of part and finishing can be made to customer requirement.
- * Other Extrusion profiles are available for greater selection with clipping system.