

TO-202, 218, 220 EXTRUDED HEATSINK

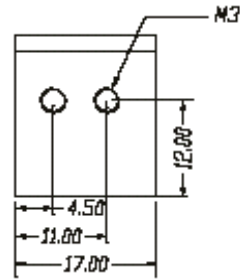

1232A000

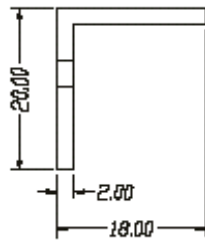

1233A000

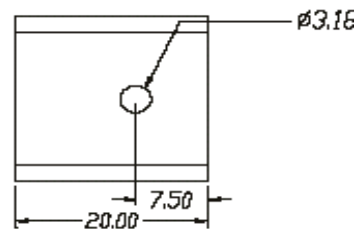
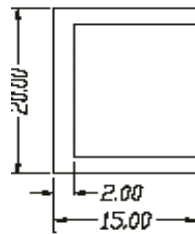

1234A000

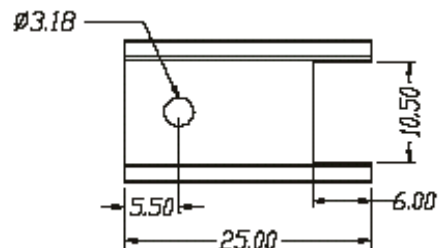
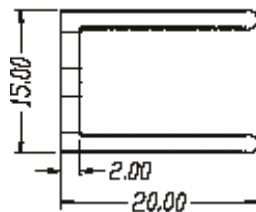

1235A000

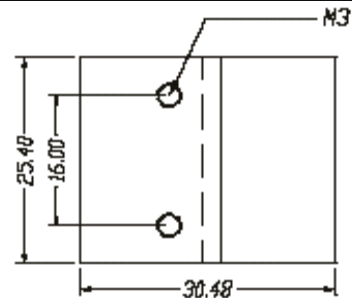
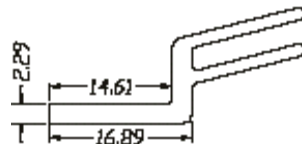

1236A000

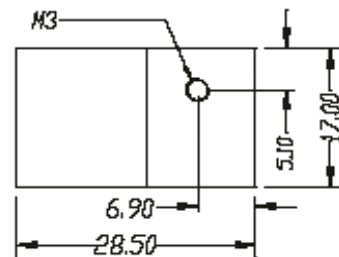
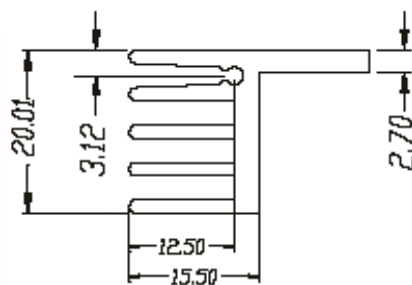

1237A000

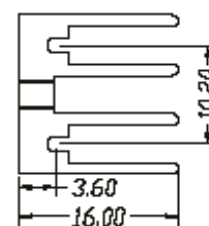
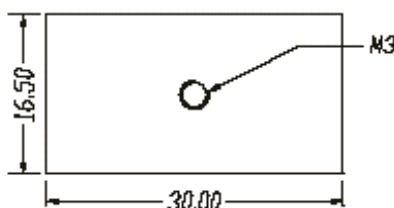

TO-202, 218, 220 EXTRUDED HEATSINK

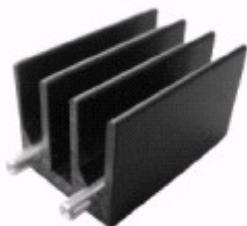
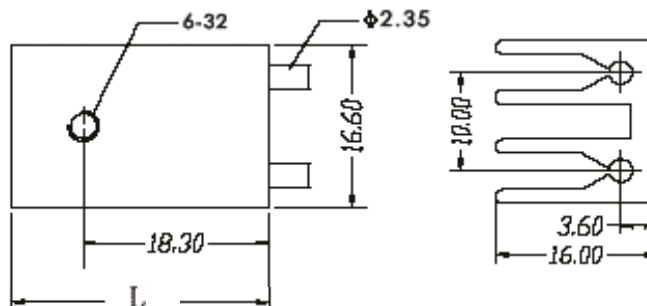
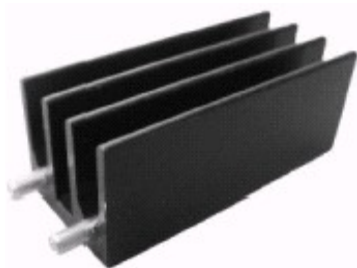

PART NO	"L"	"A" HOLE Ø	PINS
3810A285	25.4	6-32	SOLID
3811A285	38.1	6-32	SOLID
3812A285	50.0	6-32	SOLID
3710A285	25.4	M3	SOLID
3711A285	38.1	M3	SOLID
3712A285	50.0	M3	SOLID
4390A201	25.4	6-32	HOLLOW
4391A201	38.1	6-32	HOLLOW
4392A201	50.0	6-32	HOLLOW
4290A201	25.4	M3	HOLLOW
4291A201	38.1	M3	HOLLOW
4292A201	50.0	M3	HOLLOW

8538A214

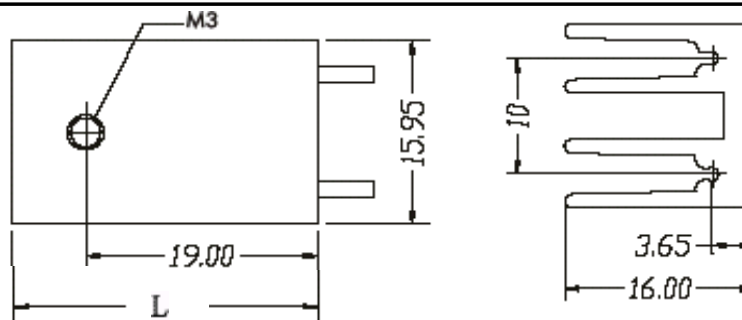
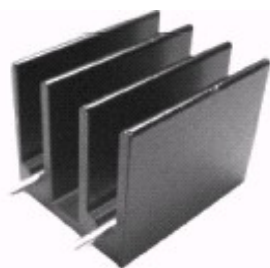
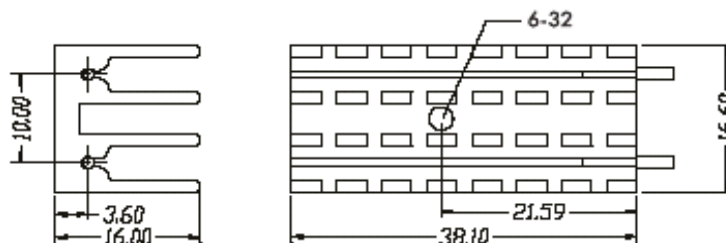
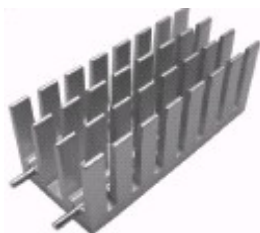

PART NO	"L" Length	Pins Ø
8525A214	25	Ø1.40mm
8530A214	30	Ø1.40mm
8535A214	35	Ø1.40mm
8540A214	40	Ø1.40mm
8545A214	45	Ø1.40mm
8550A214	50	Ø1.40mm

TO-202, 218, 220 EXTRUDED HEATSINK



8230A214

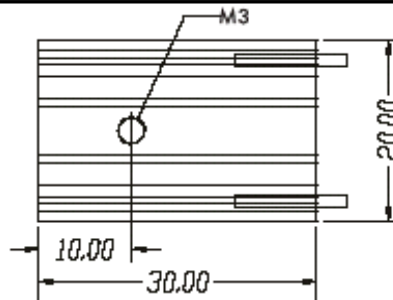
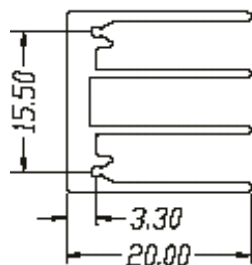
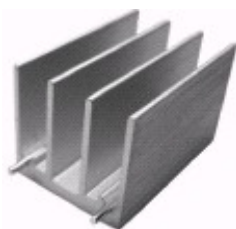

8225A214

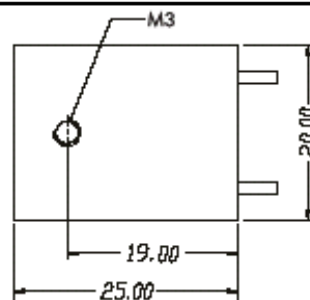
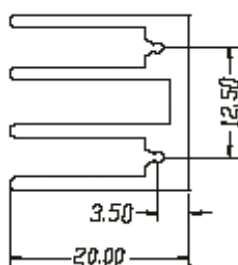
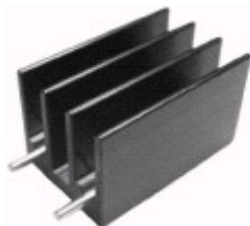

8025A212

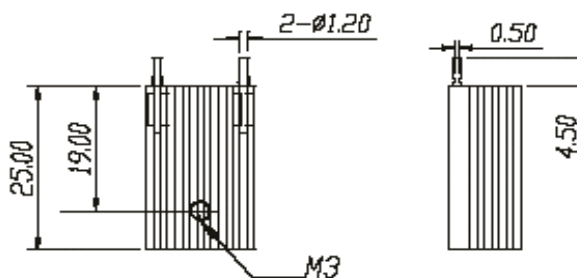
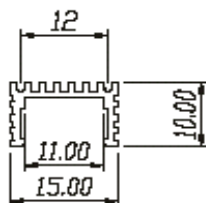

8026A221

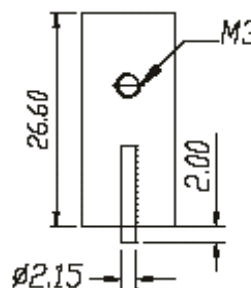
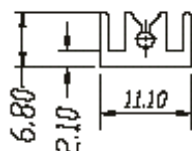

8035A213

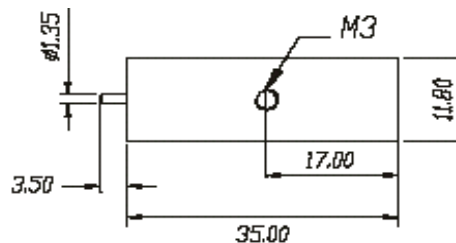
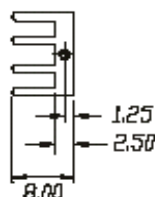

8520A222

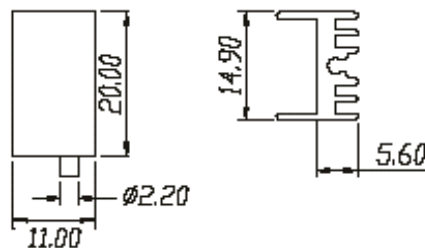
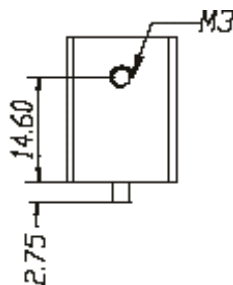
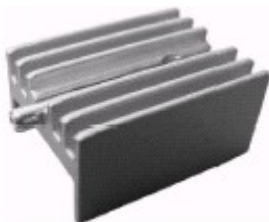

TO-202, 218, 220 EXTRUDED HEATSINK



8550A285

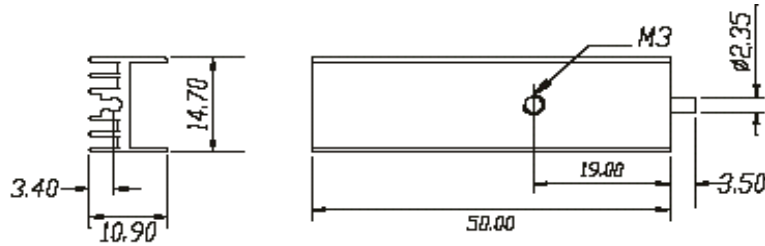

1525A214

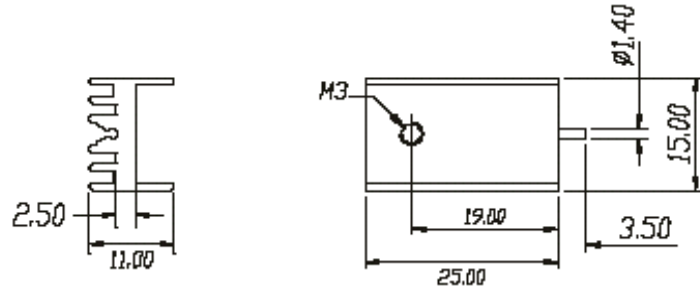

8425A285

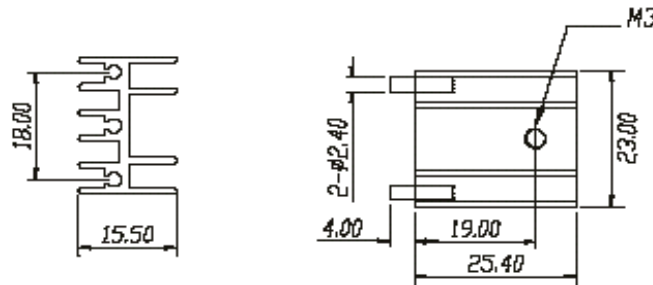
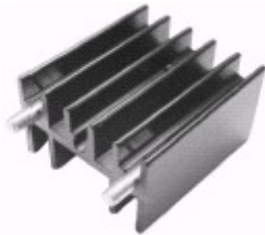

8525A285

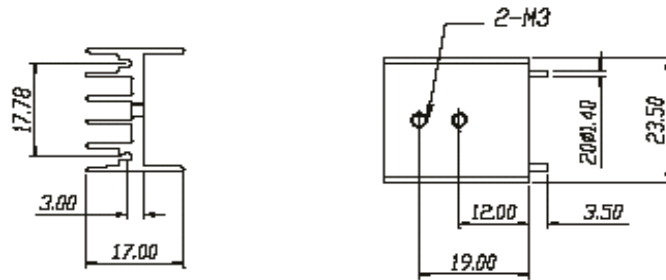
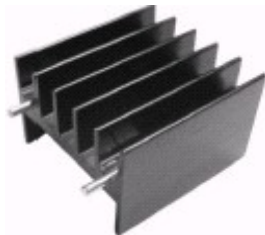

8242A223

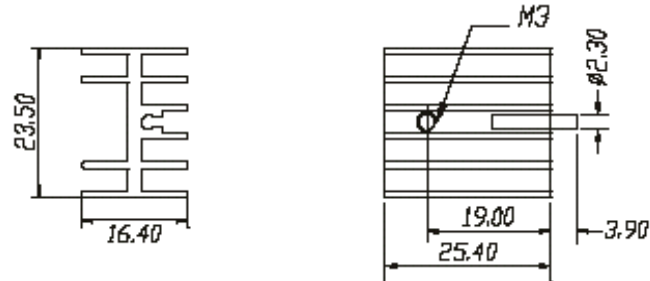

1206A225

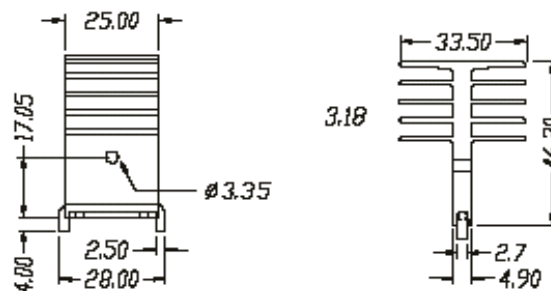

TO-202, 218, 220 EXTRUDED HEATSINK

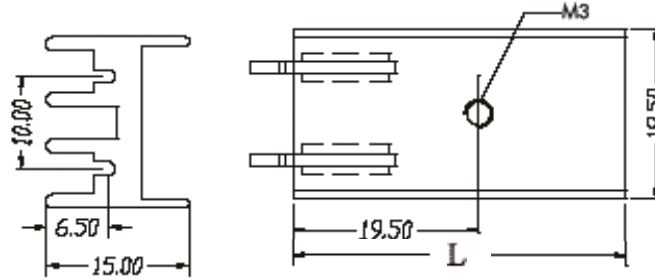
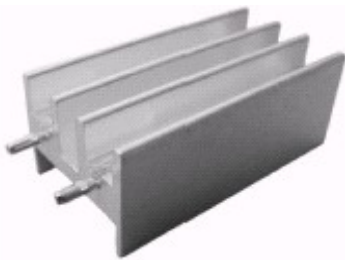

PART NO	"L"
8125A285	25.00
8130A285	30.00
8135A285	35.00
8140A285	40.00
8145A285	45.00
8150A285	50.00

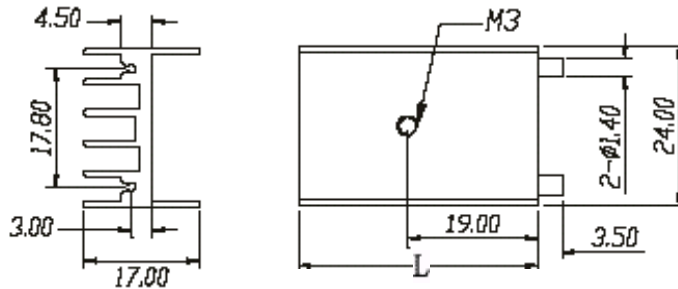
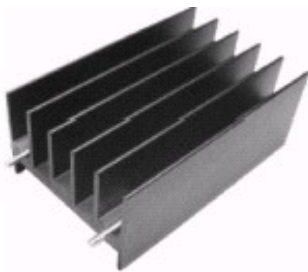

PART NO	"L"
8425A214	25.00
8430A214	30.00
8435A214	35.00
8440A214	40.00
8445A214	45.00
8450A214	50.00

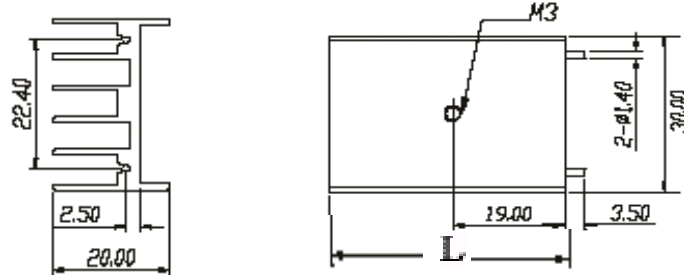
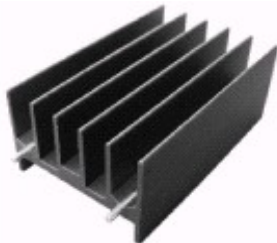
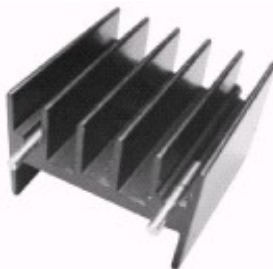

PART NO	"L"
8025A214	25.00
8030A214	30.00
8035A214	35.00
8040A214	40.00
8045A214	47.00
8050A214	50.00

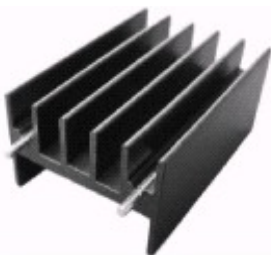

TO-202, 218, 220 EXTRUDED HEATSINK



8442A223

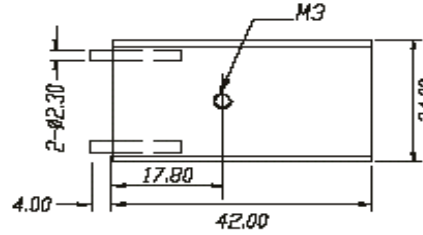
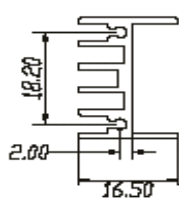
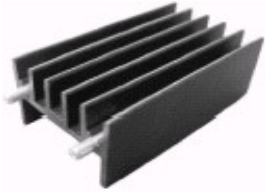

1191A285

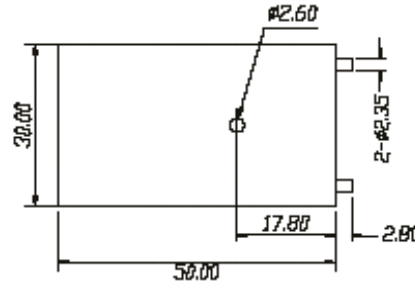
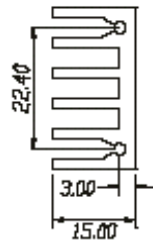
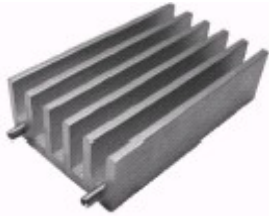

1193A214

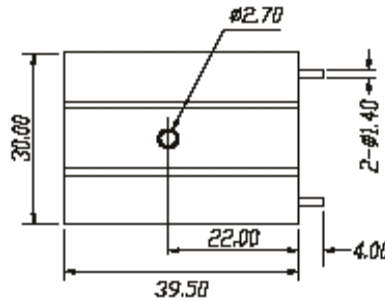
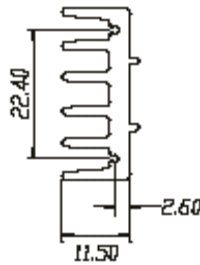
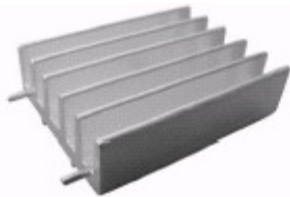

1192A214

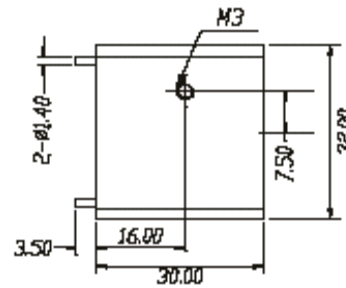
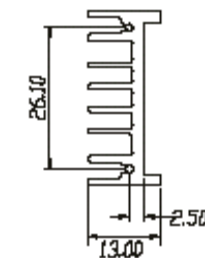

1025A214

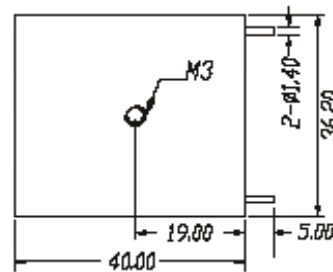
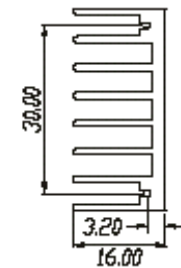
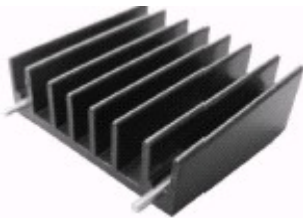

1180A214

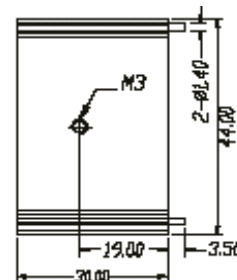
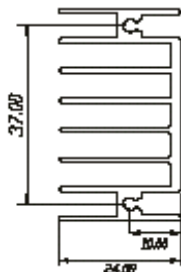

TO-202, 218, 220 EXTRUDED HEATSINK



EGT1199

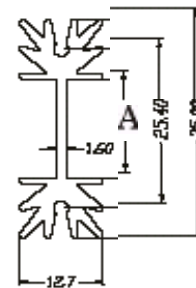
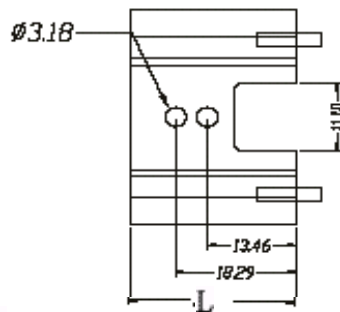
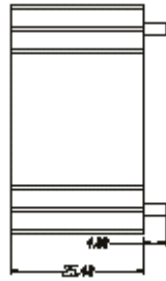
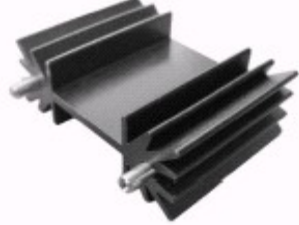

PART NO	"L"	"A"
3310A201	25.40	15.75
3311A201	38.10	15.75
3312A201	50.08	15.75
1731A201	25.40	17.02
1735A201	38.10	17.02
1732A201	50.08	17.02

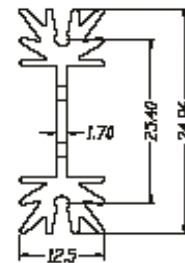
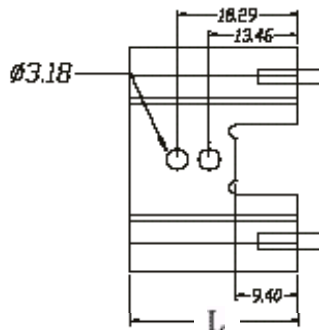

PART NO	"L"
4098A201	25.40
4099A201	38.10
4100A201	50.08

4098A202

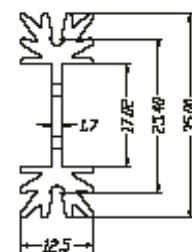
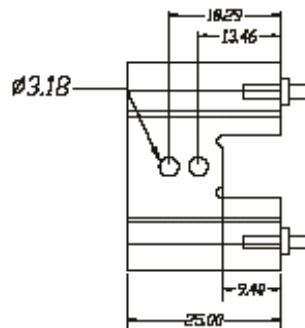

TO-202, 218, 220 EXTRUDED HEATSINK





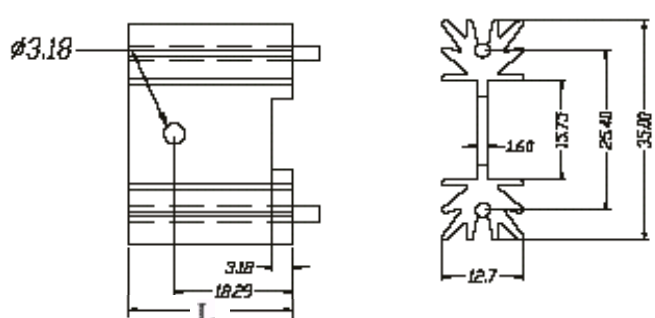



PART NO	"L"
3130A285	25.40
3131A285	38.10
3132A285	50.08
3133A285	63.50

1210235

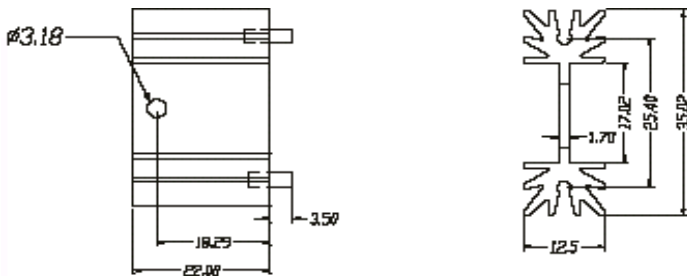



1211A201



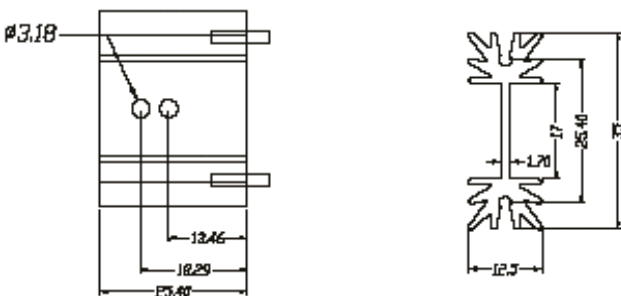

1212A201

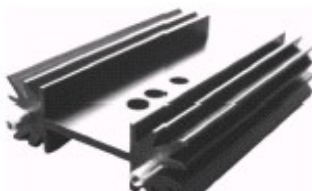

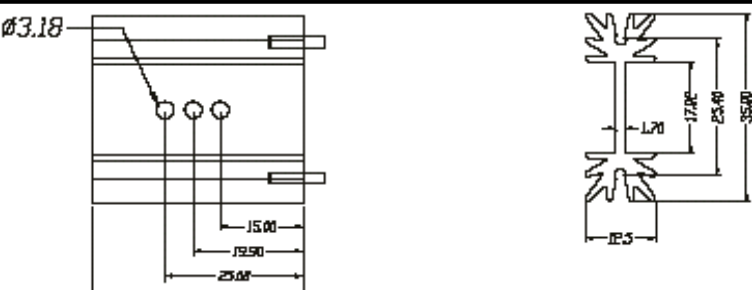

1213A801

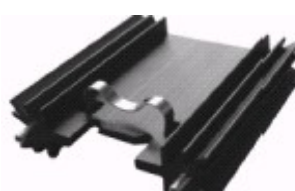

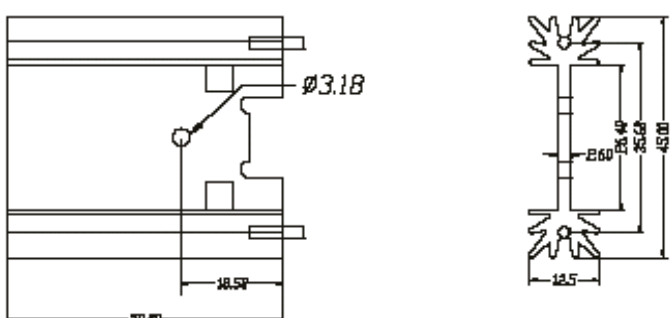

TO-202, 218, 220 EXTRUDED HEATSINK

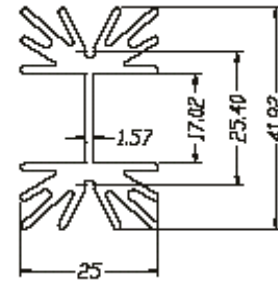
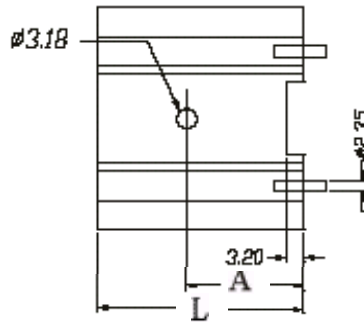
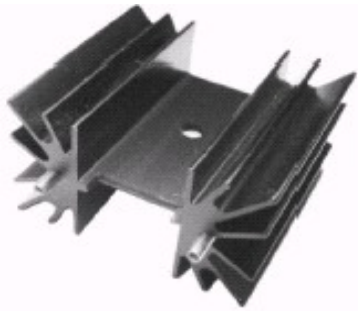

PART NO	"L"	"A"
3297A285	25.40	18.3
3298A285	38.10	18.3
3299A285	50.00	18.3
3300A285	63.40	18.3

PART NO	"L"	"A"
4296A285	25.40	21.59
4297A285	38.10	21.59
4298A285	50.00	21.59
4299A285	63.40	21.59

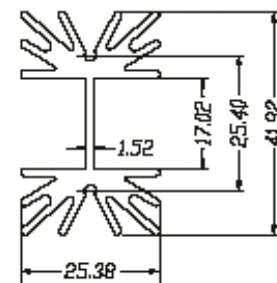
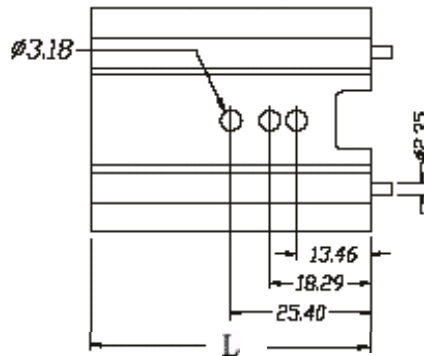
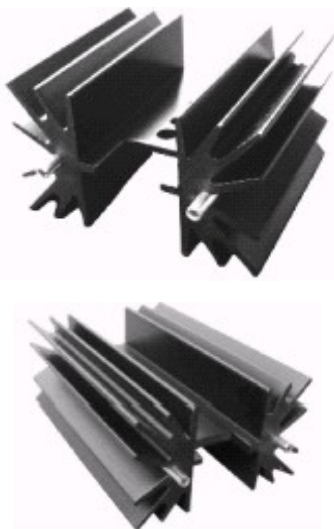

PART NO	"L"
1214A201	38.10
1215A201	50.00
1216A201	63.40

1217A201

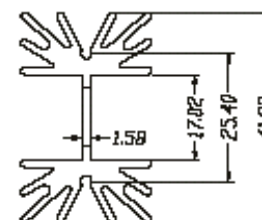
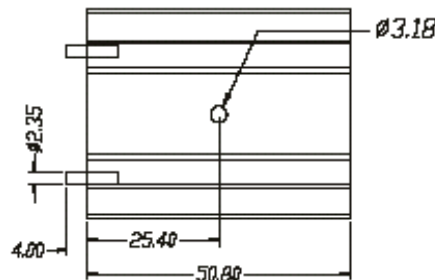

1207A225

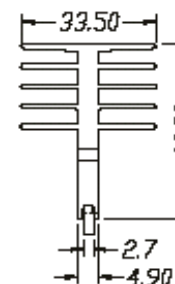
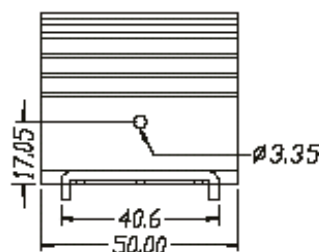

TO-202, 218, 220 & 247 EXTRUDED HEATSINK

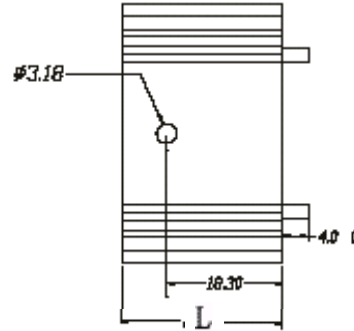
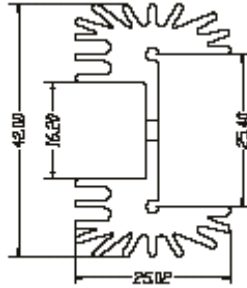
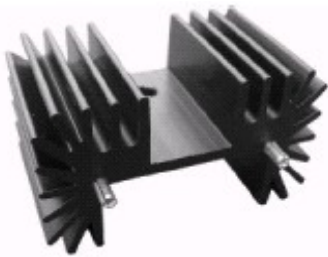

PART NO	"L"
4396A201	25.4
4397A201	38.1
4398A201	50.0
4400A201	63.4

1636A201/1625A201(With Hole)

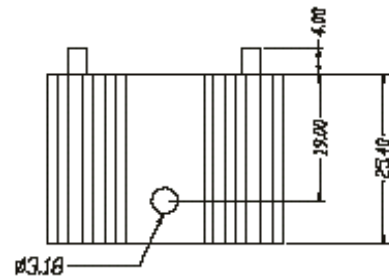
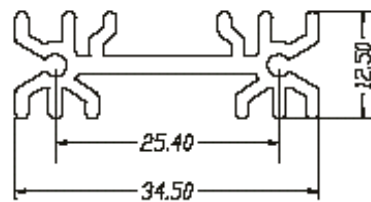

1066A201/1638A201(with Hole)

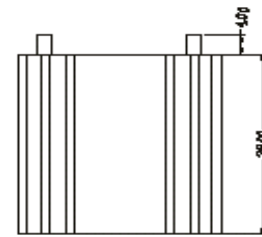
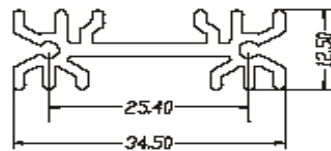

1650A201

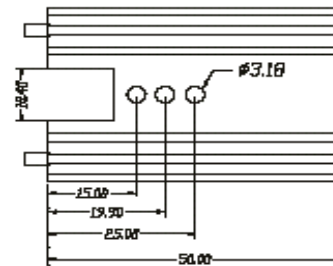
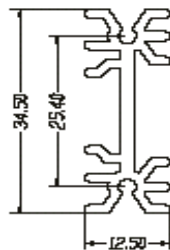

8136A222

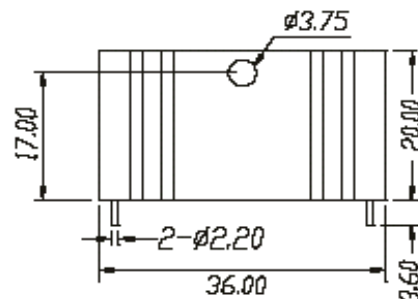
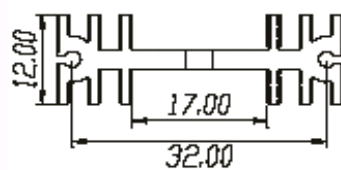

TO-202, 218, 220 EXTRUDED HEATSINK



1194A285

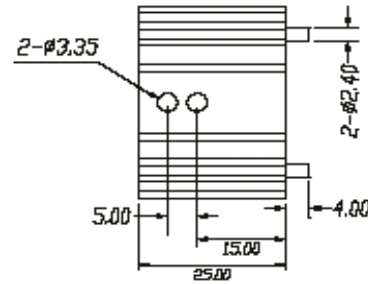
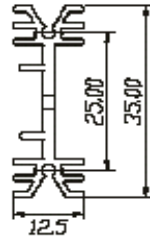

1195A285 / 1195A885(With Clip)

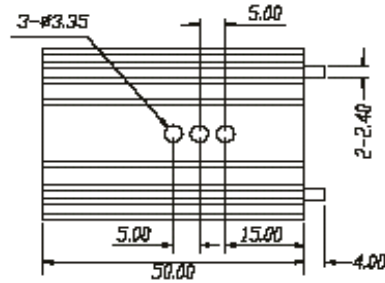
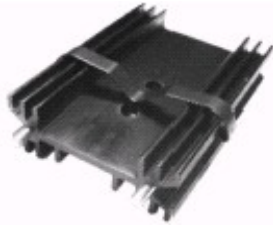

8130A214

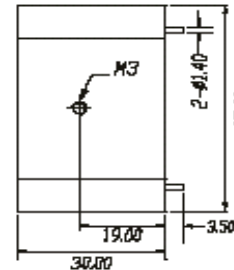
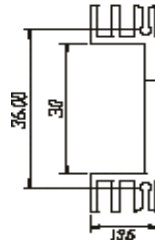

8150A214

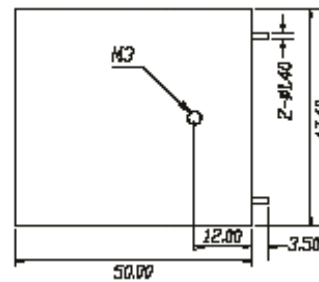
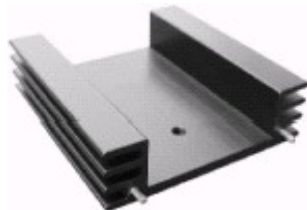

1218A214

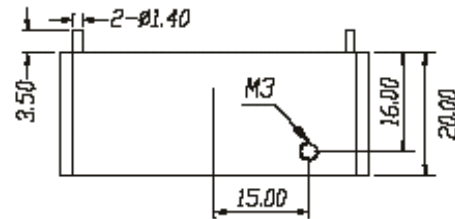
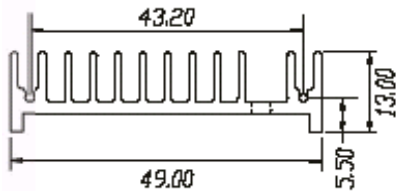

1219A214

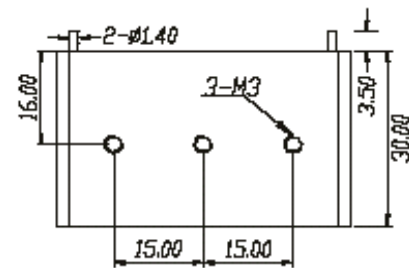
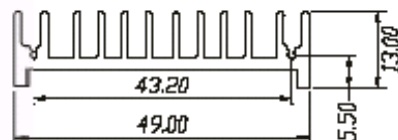
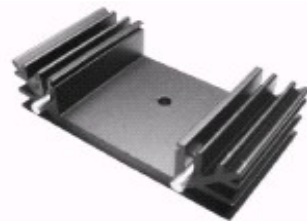

TO-218, 220 EXTRUDED HEATSINK



EGT1201 SERIES

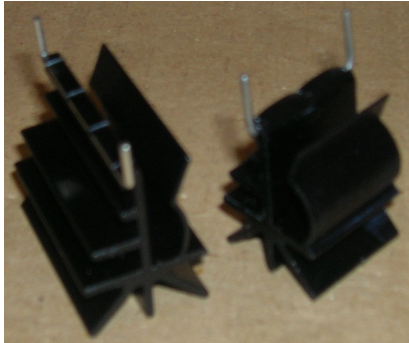

Self Clipping Feature

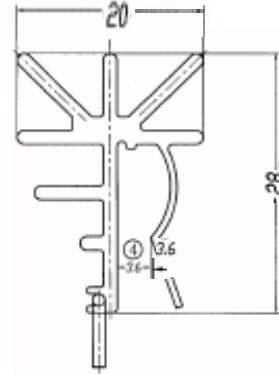
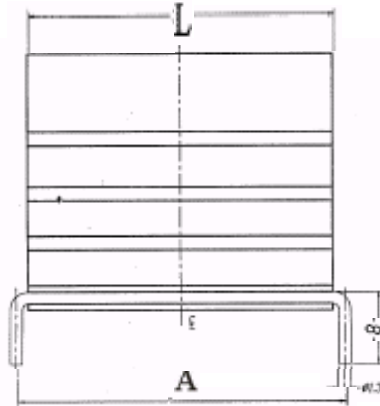

PART NO	"L"	"A"
EGT1205	33.40	21.00
EGT1201	18.40	36.00